

AOL1712
N-Channel Enhancement Mode Field Effect Transistor
SRFET™
General Description

SRFET™ AOL1712 uses advanced trench technology with a monolithically integrated Schottky diode to provide excellent $R_{DS(ON)}$, and low gate charge. This device is suitable for use as a low side FET in SMPS, load switching and general purpose applications.

- RoHS Compliant
- Halogen and Antimony Free Green Device*

Features

V_{DS} (V) = 30V
 I_D =65A (V_{GS} = 10V)
 $R_{DS(ON)} < 4.2m\Omega$ (V_{GS} = 10V)
 $R_{DS(ON)} < 5.5m\Omega$ (V_{GS} = 4.5V)

UIS Tested
 Rg,Ciss,Coss,Crss Tested

Ultra SO-8™ Top View

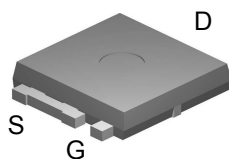

Bottom tab connected to drain

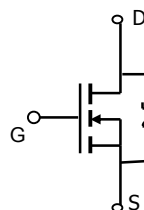

SRFET™
 Soft Recovery MOSFET:
 Integrated Schottky Diode

Absolute Maximum Ratings $T_C=25^\circ\text{C}$ unless otherwise noted

Parameter	Symbol	Maximum	Units
Drain-Source Voltage	V_{DS}	30	V
Gate-Source Voltage	V_{GS}	± 12	V
Continuous Drain Current ^{B, H}	I_D	$T_C=25^\circ\text{C}$	A
		$T_C=100^\circ\text{C}$	
Pulsed Drain Current ^C	I_{DM}	80	A
Continuous Drain Current ^A	I_{DSM}	$T_A=25^\circ\text{C}$	A
		$T_A=70^\circ\text{C}$	
Avalanche Current ^C	I_{AR}	38	A
Repetitive avalanche energy $L=0.3\text{mH}$ ^C	E_{AR}	217	mJ
Power Dissipation ^B	P_D	$T_C=25^\circ\text{C}$	W
		$T_C=100^\circ\text{C}$	
Power Dissipation ^A	P_{DSM}	$T_A=25^\circ\text{C}$	W
		$T_A=70^\circ\text{C}$	
Junction and Storage Temperature Range	T_J, T_{STG}	-55 to 175	$^\circ\text{C}$

Thermal Characteristics

Parameter	Symbol	Typ	Max	Units
Maximum Junction-to-Ambient ^A	$R_{\theta JA}$	$t \leq 10\text{s}$	19.6	$^\circ\text{C/W}$
Maximum Junction-to-Ambient ^A		Steady-State	50	$^\circ\text{C/W}$
Maximum Junction-to-Case ^D	$R_{\theta JC}$	1	1.5	$^\circ\text{C/W}$

Electrical Characteristics ($T_J=25^\circ\text{C}$ unless otherwise noted)

Symbol	Parameter	Conditions	Min	Typ	Max	Units
STATIC PARAMETERS						
BV_{DSS}	Drain-Source Breakdown Voltage	$I_D=250\mu\text{A}$, $V_{GS}=0\text{V}$	30			V
I_{DSS}	Zero Gate Voltage Drain Current	$V_{DS}=30\text{V}$, $V_{GS}=0\text{V}$ $T_J=125^\circ\text{C}$			0.1 20	mA
I_{GSS}	Gate-Body leakage current	$V_{DS}=0\text{V}$, $V_{GS}=\pm 12\text{V}$			± 100	nA
$V_{GS(th)}$	Gate Threshold Voltage	$V_{DS}=V_{GS}$, $I_D=250\mu\text{A}$	1.4	1.8	2.5	V
$I_{D(ON)}$	On state drain current	$V_{GS}=10\text{V}$, $V_{DS}=5\text{V}$	80			A
$R_{DS(ON)}$	Static Drain-Source On-Resistance	$V_{GS}=10\text{V}$, $I_D=20\text{A}$ $T_J=125^\circ\text{C}$ $V_{GS}=4.5\text{V}$, $I_D=20\text{A}$		3.5 5.5 4.4	4.2 6.6 5.5	m Ω
g_{FS}	Forward Transconductance	$V_{DS}=5\text{V}$, $I_D=20\text{A}$		90		S
V_{SD}	Diode Forward Voltage	$I_S=1\text{A}$, $V_{GS}=0\text{V}$		0.36	0.5	V
I_S	Maximum Body-Diode + Schottky Diode Continuous Current ^H				65	A
DYNAMIC PARAMETERS						
C_{iss}	Input Capacitance	$V_{GS}=0\text{V}$, $V_{DS}=15\text{V}$, $f=1\text{MHz}$		3940	5120	pF
C_{oss}	Output Capacitance			590		pF
C_{rss}	Reverse Transfer Capacitance			255		pF
R_g	Gate resistance	$V_{GS}=0\text{V}$, $V_{DS}=0\text{V}$, $f=1\text{MHz}$		0.72	1.1	Ω
SWITCHING PARAMETERS						
$Q_g(10\text{V})$	Total Gate Charge	$V_{GS}=10\text{V}$, $V_{DS}=15\text{V}$, $I_D=20\text{A}$		73	95	nC
$Q_g(4.5\text{V})$	Total Gate Charge			35		nC
Q_{gs}	Gate Source Charge			10.4		nC
Q_{gd}	Gate Drain Charge			12.4		nC
$t_{D(on)}$	Turn-On DelayTime	$V_{GS}=10\text{V}$, $V_{DS}=15\text{V}$, $R_L=0.75\Omega$, $R_{GEN}=3\Omega$		9.8		ns
t_r	Turn-On Rise Time			8.4		ns
$t_{D(off)}$	Turn-Off DelayTime			45		ns
t_f	Turn-Off Fall Time			10		ns
t_{rr}	Body Diode Reverse Recovery Time	$I_F=20\text{A}$, $dI/dt=300\text{A}/\mu\text{s}$		36	43	ns
Q_{rr}	Body Diode Reverse Recovery Charge	$I_F=20\text{A}$, $dI/dt=300\text{A}/\mu\text{s}$		32		nC

A: The value of $R_{\theta JA}$ is measured with the device in a still air environment with $T_A=25^\circ\text{C}$. The power dissipation P_{DSM} and current rating I_{DSM} are based on $T_{J(MAX)}=150^\circ\text{C}$, using steady state junction-to-ambient thermal resistance.

B: The power dissipation P_D is based on $T_{J(MAX)}=175^\circ\text{C}$, using junction-to-case thermal resistance, and is more useful in setting the upper dissipation limit for cases where additional heatsinking is used.

C: Repetitive rating, pulse width limited by junction temperature $T_{J(MAX)}=175^\circ\text{C}$.

D: The $R_{\theta JA}$ is the sum of the thermal impedance from junction to case $R_{\theta JC}$ and case to ambient.

E: The static characteristics in Figures 1 to 6 are obtained using <300us pulses, duty cycle 0.5% max.

F: These curves are based on the junction-to-case thermal impedance which is measured with the device mounted to a large heatsink, assuming a maximum junction temperature of $T_{J(MAX)}=175^\circ\text{C}$. The SOA curve provides a single pulse rating.

G: These tests are performed with the device mounted on 1 in 2 FR-4 board with 2oz. Copper, in a still air environment with $T_A=25^\circ\text{C}$.

H: The maximum current rating is limited by bond-wires.

* This device is guaranteed green after date code 8P11 (June 1ST 2008)

Rev3: Julv. 2008

THIS PRODUCT HAS BEEN DESIGNED AND QUALIFIED FOR THE CONSUMER MARKET. APPLICATIONS OR USES AS CRITICAL COMPONENTS IN LIFE SUPPORT DEVICES OR SYSTEMS ARE NOT AUTHORIZED. AOS DOES NOT ASSUME ANY LIABILITY ARISING OUT OF SUCH APPLICATIONS OR USES OF ITS PRODUCTS. AOS RESERVES THE RIGHT TO IMPROVE PRODUCT DESIGN, FUNCTIONS AND RELIABILITY WITHOUT NOTICE.

TYPICAL ELECTRICAL AND THERMAL CHARACTERISTICS

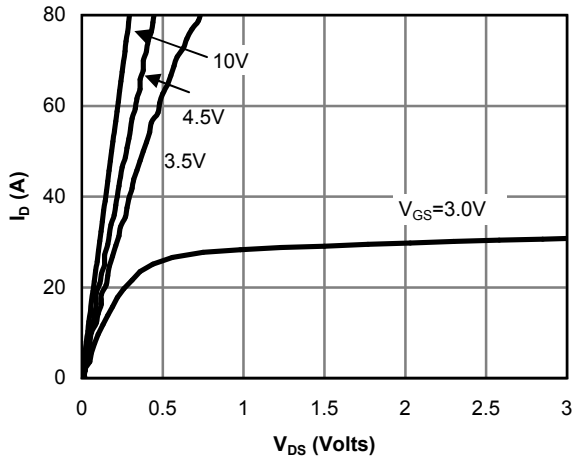

Figure 1: On-Region Characteristics

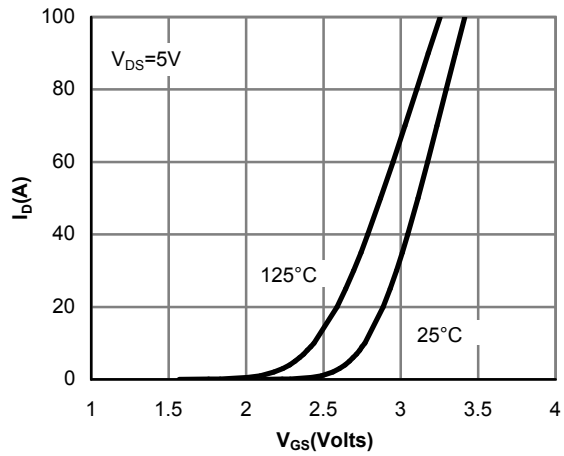

Figure 2: Transfer Characteristics

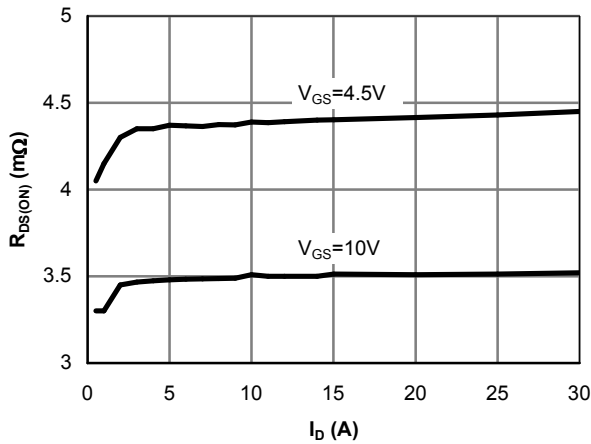

Figure 3: On-Resistance vs. Drain Current and Gate Voltage

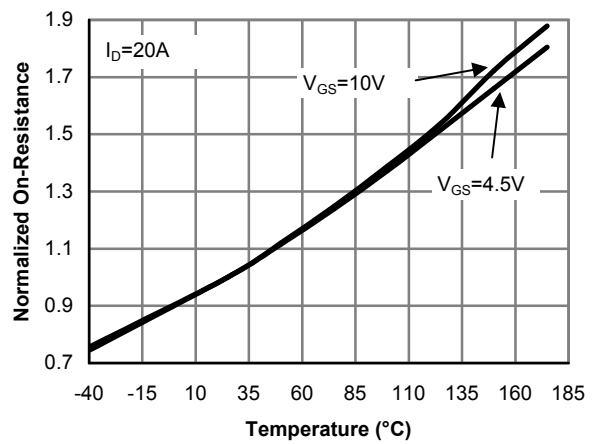

Figure 4: On-Resistance vs. Junction Temperature

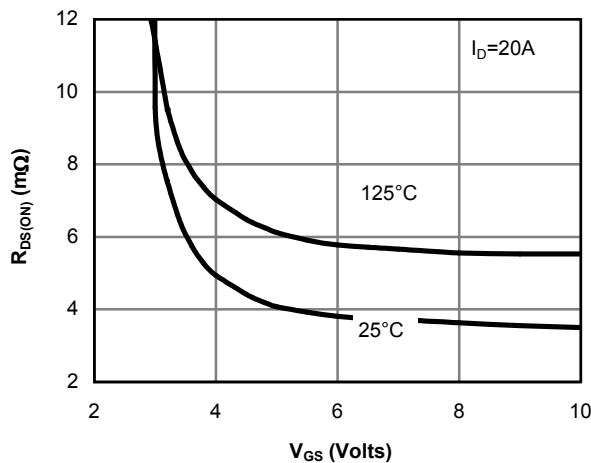

Figure 5: On-Resistance vs. Gate-Source Voltage

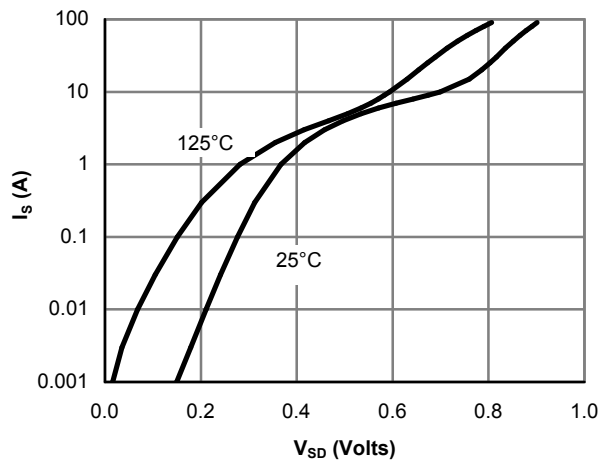

Figure 6: Body-Diode Characteristics

TYPICAL ELECTRICAL AND THERMAL CHARACTERISTICS

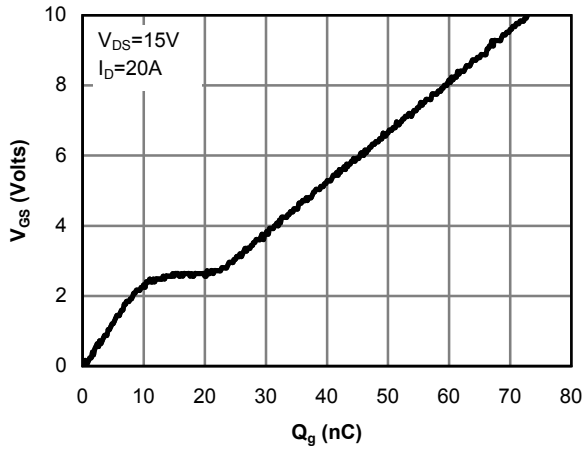

Figure 7: Gate-Charge Characteristics

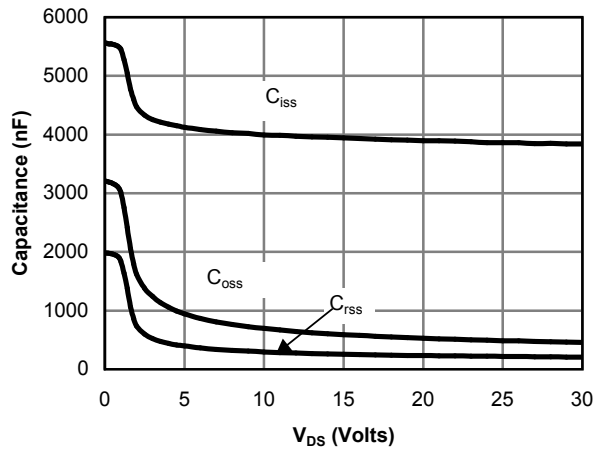

Figure 8: Capacitance Characteristics

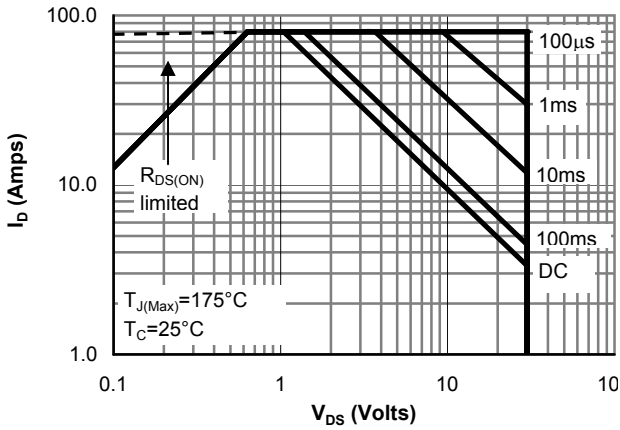

Figure 9: Maximum Forward Biased Safe Operating Area (Note F)

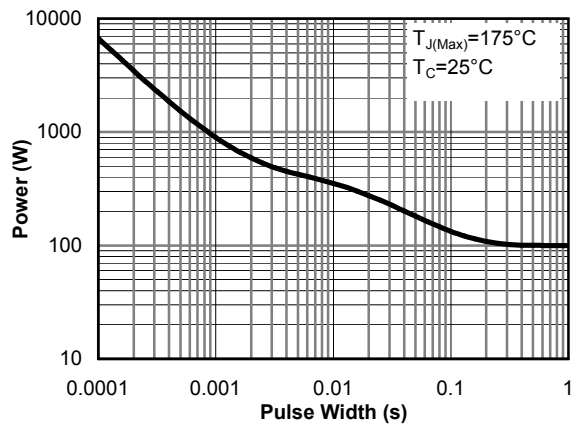

Figure 10: Single Pulse Power Rating Junction-to-Case (Note F)

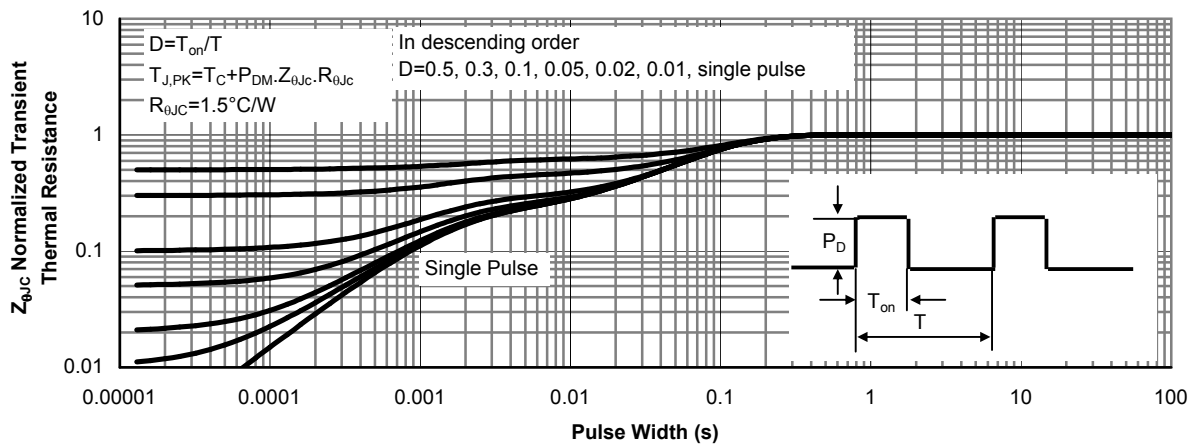

Figure 11: Normalized Maximum Transient Thermal Impedance (Note F)

TYPICAL ELECTRICAL AND THERMAL CHARACTERISTICS

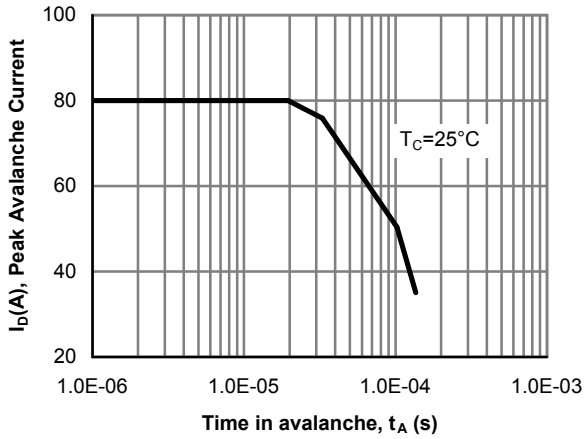

Figure 12: Single Pulse Avalanche capability

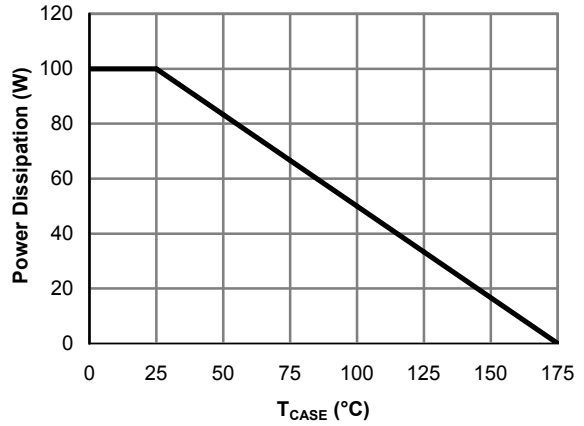

Figure 13: Power De-rating (Note B)

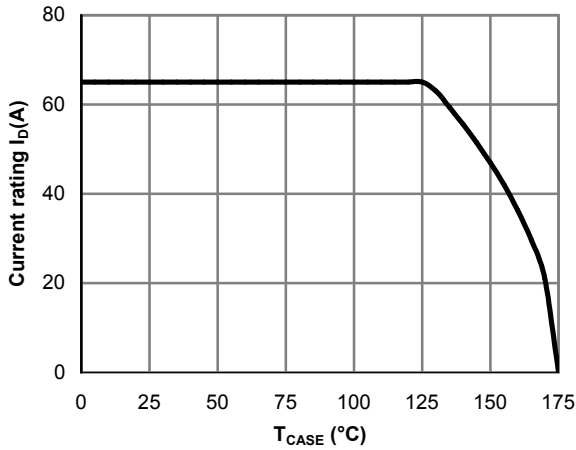

Figure 14: Current De-rating (Note B)

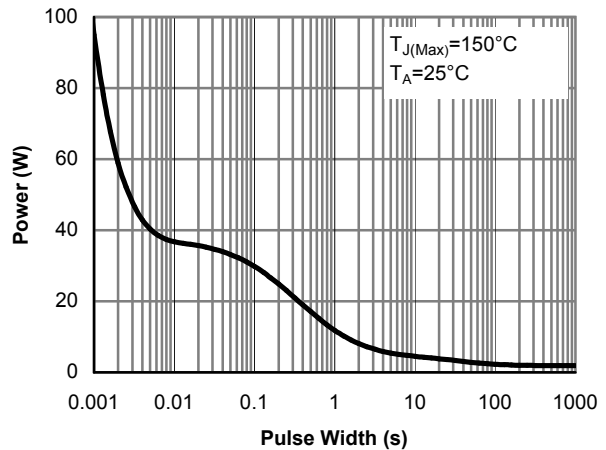

Figure 15: Single Pulse Power Rating Junction-to-Ambient (Note G)

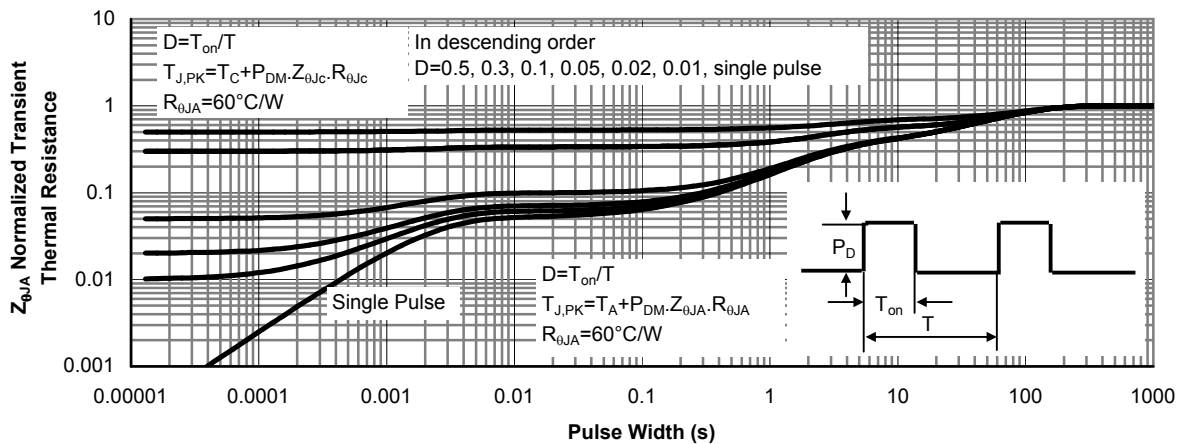
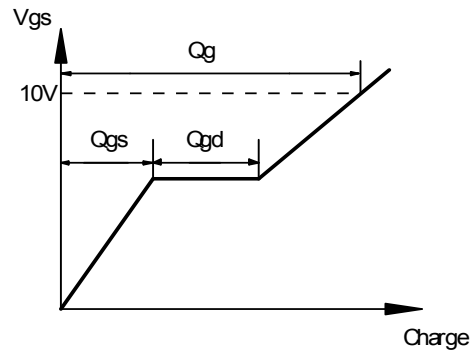
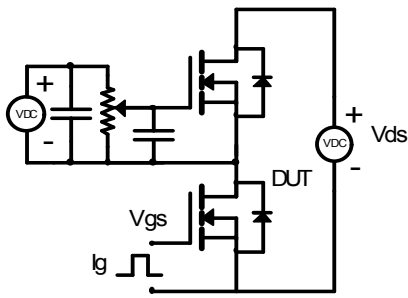
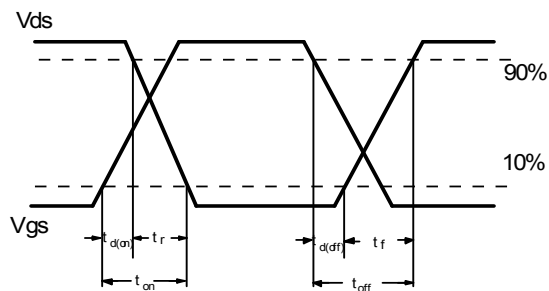
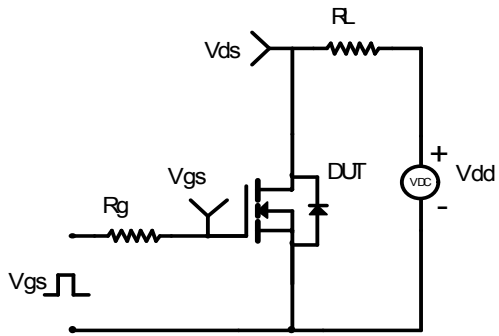

Figure 16: Normalized Maximum Transient Thermal Impedance (Note G)

Gate Charge Test Circuit & Waveform



Resistive Switching Test Circuit & Waveforms



Unclamped Inductive Switching (UIS) Test Circuit & Waveforms

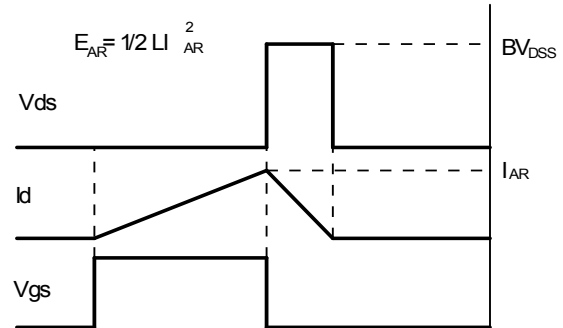
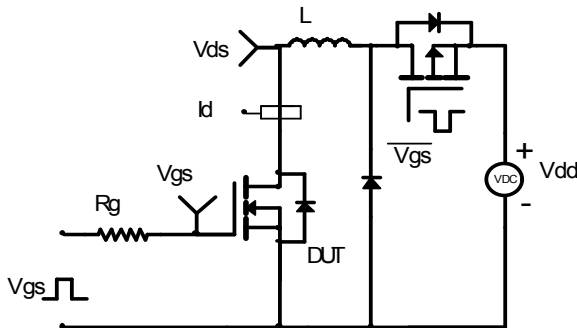

Diode Recovery Test Circuit & Waveforms

