

General Description

The AON6908A is designed to provide a high efficiency synchronous buck power stage with optimal layout and board space utilization. It includes two specialized MOSFETs in a dual Power DFN5x6 package. The Q1 "High Side" MOSFET is designed to minimize switching losses. The Q2 "Low Side" MOSFET is an SRFET™ that features low $R_{DS(ON)}$ to reduce conduction losses as well as an integrated Schottky diode with low Q_{RR} and V_f to reduce switching losses. The AON6908A is well suited for use in compact DC/DC converter applications.

Product Summary

	Q1	Q2
V_{DS}	30V	30V
I_D (at $V_{GS}=10V$)	46A	80A
$R_{DS(ON)}$ (at $V_{GS}=10V$)	<8.9m Ω	<3.6m Ω
$R_{DS(ON)}$ (at $V_{GS} = 4.5V$)	<12.5m Ω	<4.5m Ω

100% UIS Tested
 100% Rg Tested

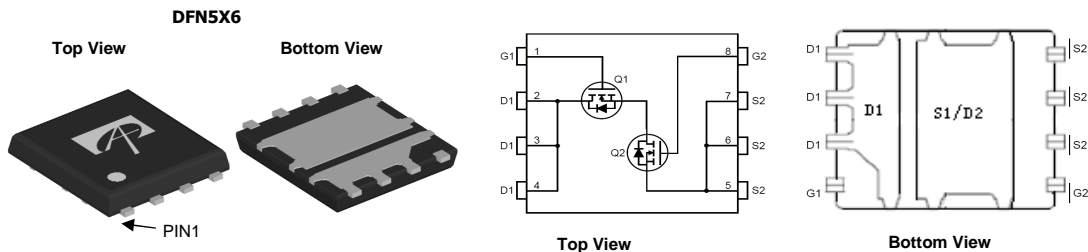

Absolute Maximum Ratings $T_A=25^\circ\text{C}$ unless otherwise noted

Parameter	Symbol	Max Q1	Max Q2	Units
Drain-Source Voltage	V_{DS}	30		V
Gate-Source Voltage	V_{GS}	± 20	± 12	V
Continuous Drain Current ^G	I_D	$T_C=25^\circ\text{C}$	46	80
		$T_C=100^\circ\text{C}$	28	62
Pulsed Drain Current ^C	I_{DM}	100	200	A
Continuous Drain Current	I_{DSM}	$T_A=25^\circ\text{C}$	11.5	17
		$T_A=70^\circ\text{C}$	9	13.5
Avalanche Current ^C	I_{AS}, I_{AR}	27	40	A
Avalanche Energy $L=0.1\text{mH}$ ^C	E_{AS}, E_{AR}	36	80	mJ
V_{DS} Spike	V_{SPIKE}	36	36	V
Power Dissipation ^B	P_D	$T_C=25^\circ\text{C}$	31	78
		$T_C=100^\circ\text{C}$	12	31
Power Dissipation ^A	P_{DSM}	$T_A=25^\circ\text{C}$	1.9	2.1
		$T_A=70^\circ\text{C}$	1.2	1.3
Junction and Storage Temperature Range	T_J, T_{STG}	-55 to 150		$^\circ\text{C}$

Thermal Characteristics

Parameter	Symbol	Typ Q1	Typ Q2	Max Q1	Max Q2	Units
Maximum Junction-to-Ambient ^A	$R_{\theta JA}$	29	24	35	29	$^\circ\text{C}/\text{W}$
Maximum Junction-to-Ambient ^{A,D}		56	50	67	60	$^\circ\text{C}/\text{W}$
Maximum Junction-to-Case	$R_{\theta JC}$	3.3	1.2	4	1.6	$^\circ\text{C}/\text{W}$

Q1 Electrical Characteristics (T_J=25°C unless otherwise noted)

Symbol	Parameter	Conditions	Min	Typ	Max	Units
STATIC PARAMETERS						
BV _{DSS}	Drain-Source Breakdown Voltage	I _D =250μA, V _{GS} =0V	30			V
I _{DSS}	Zero Gate Voltage Drain Current	V _{DS} =30V, V _{GS} =0V T _J =55°C			1 5	μA
I _{GSS}	Gate-Body leakage current	V _{DS} =0V, V _{GS} = ±20V			100	nA
V _{GS(th)}	Gate Threshold Voltage	V _{DS} =V _{GS} , I _D =250μA	1.3	1.8	2.4	V
I _{D(ON)}	On state drain current	V _{GS} =10V, V _{DS} =5V	100			A
R _{DS(ON)}	Static Drain-Source On-Resistance	V _{GS} =10V, I _D =11.5A T _J =125°C		7.4	8.9	mΩ
		V _{GS} =4.5V, I _D =11.5A		10	12.5	
g _{FS}	Forward Transconductance	V _{DS} =5V, I _D =11.5A		50		S
V _{SD}	Diode Forward Voltage	I _S =1A, V _{GS} =0V		0.7	1	V
I _S	Maximum Body-Diode Continuous Current				34	A
DYNAMIC PARAMETERS						
C _{iss}	Input Capacitance	V _{GS} =0V, V _{DS} =15V, f=1MHz	680	850	1110	pF
C _{oss}	Output Capacitance		260	380	540	pF
C _{riss}	Reverse Transfer Capacitance		18	30	51	pF
R _g	Gate resistance	V _{GS} =0V, V _{DS} =0V, f=1MHz	0.7	1.4	2.1	Ω
SWITCHING PARAMETERS						
Q _{g(10V)}	Total Gate Charge	V _{GS} =10V, V _{DS} =15V, I _D =11.5A	10	12.5	15	nC
Q _{g(4.5V)}	Total Gate Charge		4.6	5.7	6.9	nC
Q _{gs}	Gate Source Charge		1.6	2	2.4	nC
Q _{gd}	Gate Drain Charge		1.5	2.6	3.6	nC
t _{D(on)}	Turn-On DelayTime	V _{GS} =10V, V _{DS} =15V, R _L =0.75Ω, R _{GEN} =3Ω		5		ns
t _r	Turn-On Rise Time			9.5		ns
t _{D(off)}	Turn-Off DelayTime			18.5		ns
t _f	Turn-Off Fall Time			4		ns
t _{rr}	Body Diode Reverse Recovery Time	I _F =11.5A, dI/dt=500A/μs	8	10.5	13	ns
Q _{rr}	Body Diode Reverse Recovery Charge	I _F =11.5A, dI/dt=500A/μs	13	17.2	21	nC

A. The value of R_{θJA} is measured with the device mounted on 1in² FR-4 board with 2oz. Copper, in a still air environment with T_A=25°C. The Power dissipation P_{DSM} is based on R_{θJA} and the maximum allowed junction temperature of 150°C. The value in any given application depends on the user's specific board design.

B. The power dissipation P_D is based on T_{J(MAX)}=150°C, using junction-to-case thermal resistance, and is more useful in setting the upper dissipation limit for cases where additional heatsinking is used.

C. Repetitive rating, pulse width limited by junction temperature T_{J(MAX)}=150°C. Ratings are based on low frequency and duty cycles to keep initial T_J=25°C.

D. The R_{θJA} is the sum of the thermal impedance from junction to case R_{θJC} and case to ambient.

E. The static characteristics in Figures 1 to 6 are obtained using <300μs pulses, duty cycle 0.5% max.

F. These curves are based on the junction-to-case thermal impedance which is measured with the device mounted to a large heatsink, assuming a maximum junction temperature of T_{J(MAX)}=150°C. The SOA curve provides a single pulse rating g.

G. The maximum current rating is limited by package.

H. These tests are performed with the device mounted on 1 in² FR-4 board with 2oz. Copper, in a still air environment with T_A=25°C.

COMPONENTS IN LIFE SUPPORT DEVICES OR SYSTEMS ARE NOT AUTHORIZED. AOS DOES NOT ASSUME ANY LIABILITY ARISING OUT OF SUCH APPLICATIONS OR USES OF ITS PRODUCTS. AOS RESERVES THE RIGHT TO IMPROVE PRODUCT DESIGN, FUNCTIONS AND RELIABILITY WITHOUT NOTICE.

Q1-CHANNEL: TYPICAL ELECTRICAL AND THERMAL CHARACTERISTICS

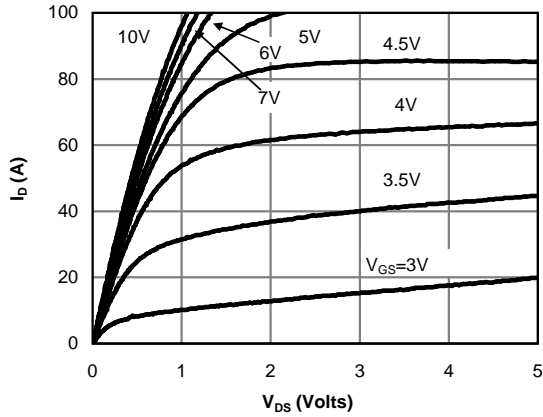

Fig 1: On-Region Characteristics (Note E)

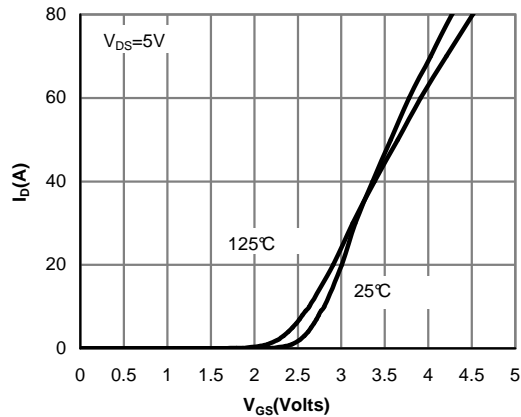

Figure 2: Transfer Characteristics (Note E)

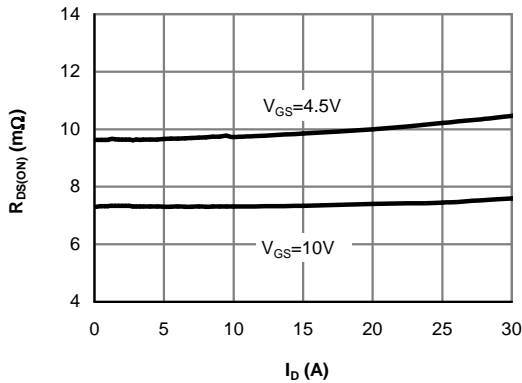

Figure 3: On-Resistance vs. Drain Current and Gate Voltage (Note E)

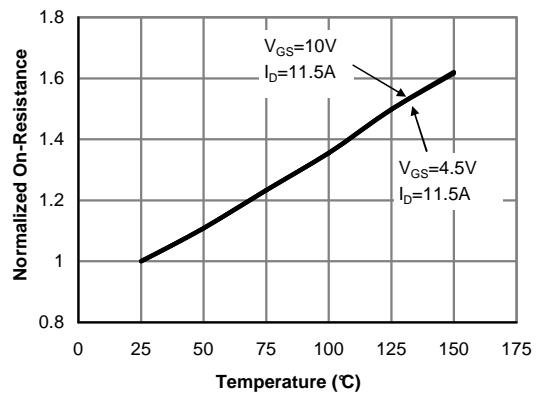

Figure 4: On-Resistance vs. Junction Temperature (Note E)

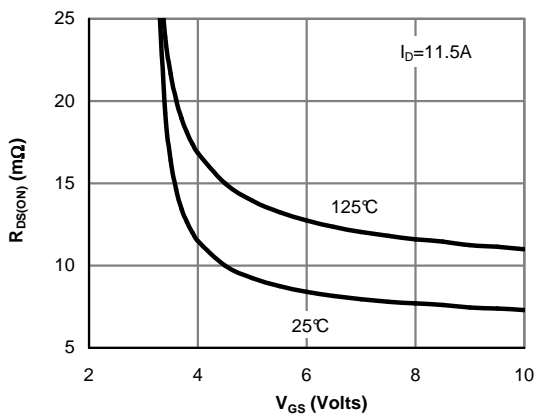

Figure 5: On-Resistance vs. Gate-Source Voltage (Note E)

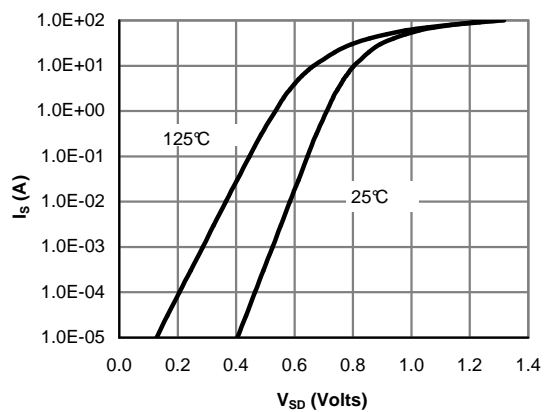

Figure 6: Body-Diode Characteristics (Note E)

Q1-CHANNEL: TYPICAL ELECTRICAL AND THERMAL CHARACTERISTICS

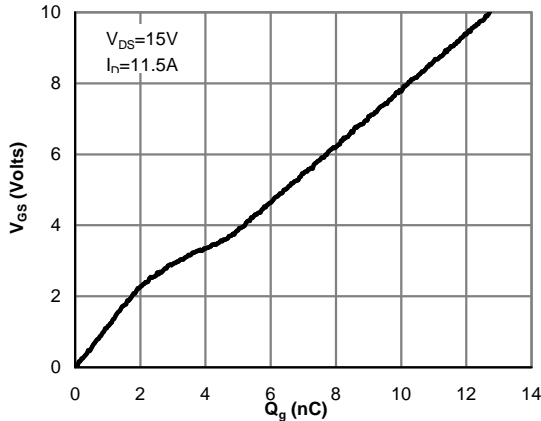

Figure 7: Gate-Charge Characteristics

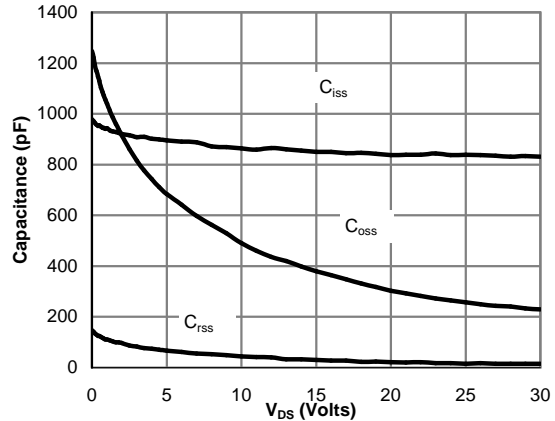

Figure 8: Capacitance Characteristics

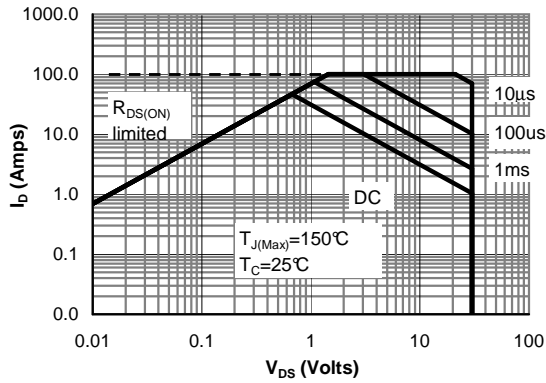

Figure 9: Maximum Forward Biased Safe Operating Area (Note F)

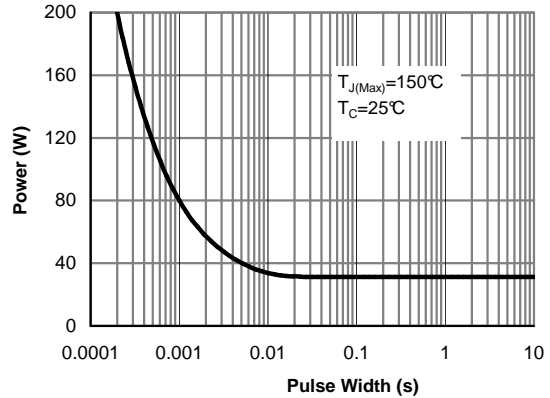

Figure 10: Single Pulse Power Rating Junction-to-Case (Note F)

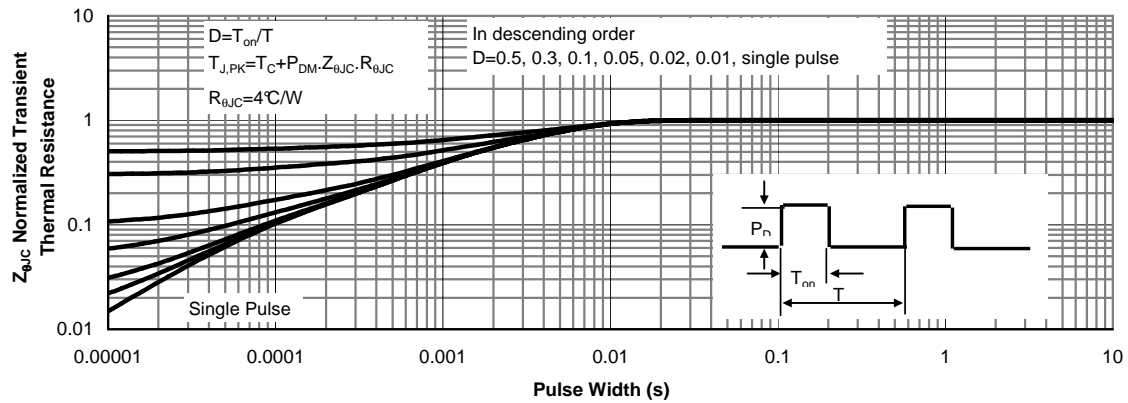

Figure 11: Normalized Maximum Transient Thermal Impedance (Note F)

Q1-CHANNEL: TYPICAL ELECTRICAL AND THERMAL CHARACTERISTICS

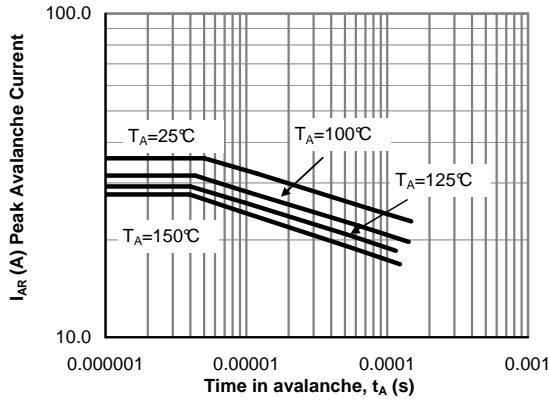

Figure 12: Single Pulse Avalanche capability (Note C)

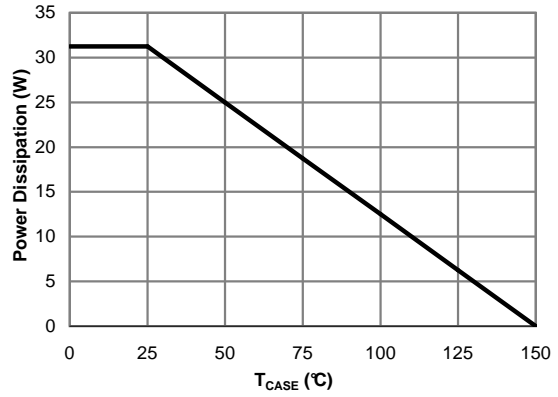

Figure 13: Power De-rating (Note F)

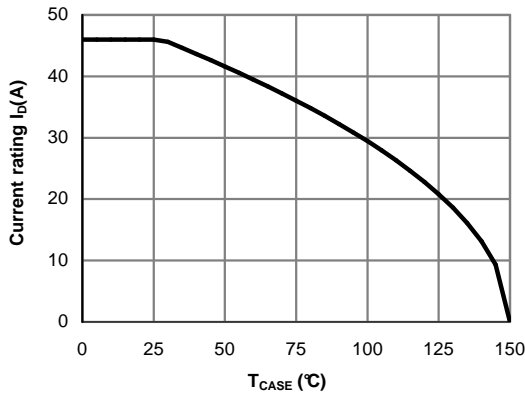

Figure 14: Current De-rating (Note F)

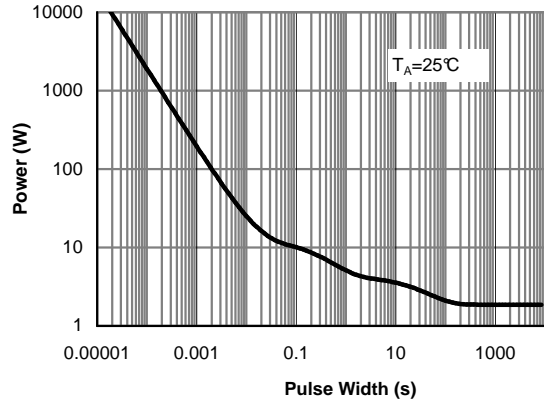

Figure 15: Single Pulse Power Rating Junction-to-Ambient (Note H)

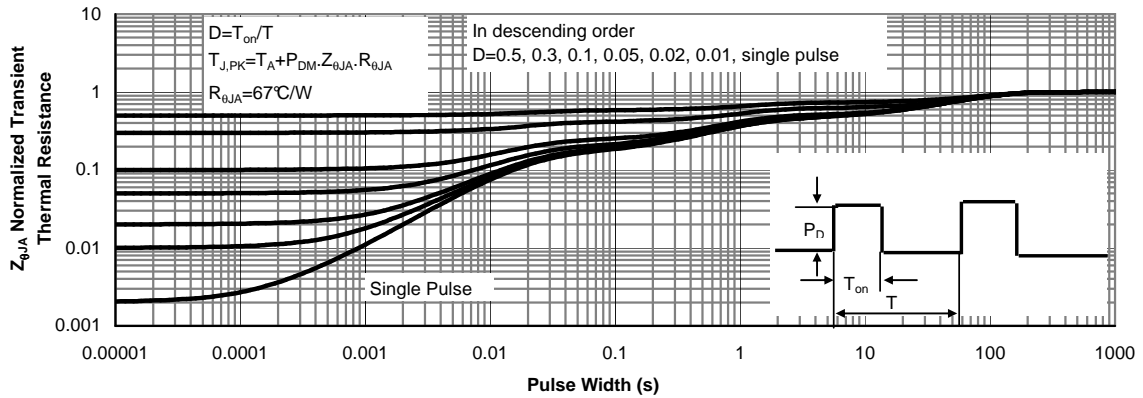

Figure 16: Normalized Maximum Transient Thermal Impedance (Note H)

Q2 Electrical Characteristics (T_J=25°C unless otherwise noted)

Symbol	Parameter	Conditions	Min	Typ	Max	Units	
STATIC PARAMETERS							
BV _{DSS}	Drain-Source Breakdown Voltage	I _D =10mA, V _{GS} =0V	30			V	
I _{DSS}	Zero Gate Voltage Drain Current	V _{DS} =30V, V _{GS} =0V T _J =55°C			0.5 100	mA	
I _{GSS}	Gate-Body leakage current	V _{DS} =0V, V _{GS} = ±12V			100	nA	
V _{GS(th)}	Gate Threshold Voltage	V _{DS} =V _{GS} , I _D =250μA	1	1.5	2	V	
I _{D(ON)}	On state drain current	V _{GS} =10V, V _{DS} =5V	200			A	
R _{DS(ON)}	Static Drain-Source On-Resistance	V _{GS} =10V, I _D =20A T _J =125°C		2.9 4.3	3.6 5.2	mΩ	
		V _{GS} =4.5V, I _D =20A		3.3	4.5	mΩ	
g _{FS}	Forward Transconductance	V _{DS} =5V, I _D =20A		115		S	
V _{SD}	Diode Forward Voltage	I _S =1A, V _{GS} =0V		0.4	0.7	V	
I _S	Maximum Body-Diode Continuous Current ⁶				80	A	
DYNAMIC PARAMETERS							
C _{iss}	Input Capacitance	V _{GS} =0V, V _{DS} =15V, f=1MHz	3500	4380	5260	pF	
C _{oss}	Output Capacitance		340	490	640	pF	
C _{riss}	Reverse Transfer Capacitance		160	280	400	pF	
R _g	Gate resistance	V _{GS} =0V, V _{DS} =0V, f=1MHz	0.3	0.7	1.1	Ω	
SWITCHING PARAMETERS							
Q _{g(4.5V)}	Total Gate Charge	V _{GS} =10V, V _{DS} =15V, I _D =20A	24	31	38	nC	
Q _{gs}	Gate Source Charge				11		nC
Q _{gd}	Gate Drain Charge				9		nC
t _{D(on)}	Turn-On DelayTime	V _{GS} =10V, V _{DS} =15V, R _L =0.75Ω, R _{GEN} =3Ω		10		ns	
t _r	Turn-On Rise Time			6		ns	
t _{D(off)}	Turn-Off DelayTime			50		ns	
t _f	Turn-Off Fall Time			7		ns	
t _{rr}	Body Diode Reverse Recovery Time	I _F =20A, dI/dt=500A/μs	9	12	15	ns	
Q _{rr}	Body Diode Reverse Recovery Charge	I _F =20A, dI/dt=500A/μs	17	22	27	nC	

A. The value of R_{θJA} is measured with the device mounted on 1in² FR-4 board with 2oz. Copper, in a still air environment with T_A=25°C. The Power dissipation P_{DSM} is based on R_{θJA} and the maximum allowed junction temperature of 150°C. The value in any given application depends on the user's specific board design.

B. The power dissipation P_D is based on T_{J(MAX)}=150°C, using junction-to-case thermal resistance, and is more useful in setting the upper dissipation limit for cases where additional heatsinking is used.

C. Repetitive rating, pulse width limited by junction temperature T_{J(MAX)}=150°C. Ratings are based on low frequency and duty cycles to keep initial T_J=25°C.

D. The R_{θJA} is the sum of the thermal impedance from junction to case R_{θJC} and case to ambient.

E. The static characteristics in Figures 1 to 6 are obtained using <300μs pulses, duty cycle 0.5% max.

F. These curves are based on the junction-to-case thermal impedance which is measured with the device mounted to a large heatsink, assuming a maximum junction temperature of T_{J(MAX)}=150°C. The SOA curve provides a single pulse rating.

G. These tests are performed with the device mounted on 1 in² FR-4 board with 2oz. Copper, in a still air environment with T_A=25°C.

COMPONENTS IN LIFE SUPPORT DEVICES OR SYSTEMS ARE NOT AUTHORIZED. AOS DOES NOT ASSUME ANY LIABILITY ARISING OUT OF SUCH APPLICATIONS OR USES OF ITS PRODUCTS. AOS RESERVES THE RIGHT TO IMPROVE PRODUCT DESIGN, FUNCTIONS AND RELIABILITY WITHOUT NOTICE.

Q2-CHANNEL: TYPICAL ELECTRICAL AND THERMAL CHARACTERISTICS

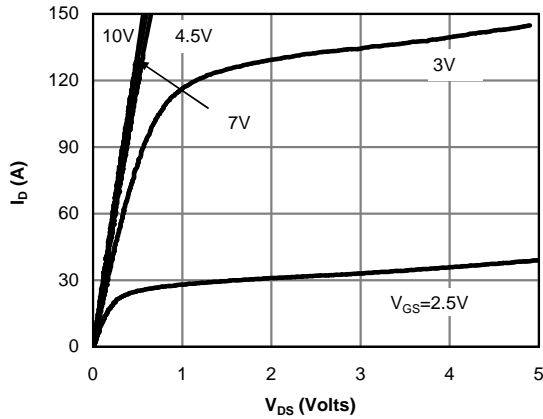

Figure 1: On-Region Characteristics (Note E)

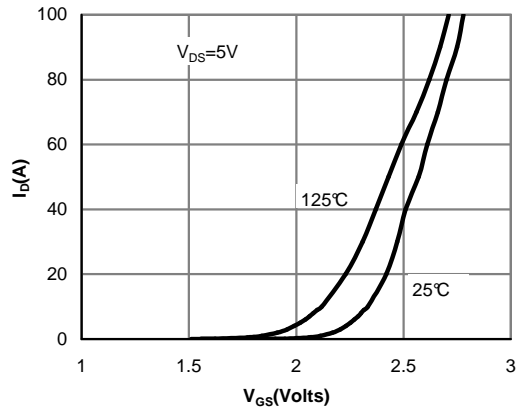

Figure 2: Transfer Characteristics (Note E)

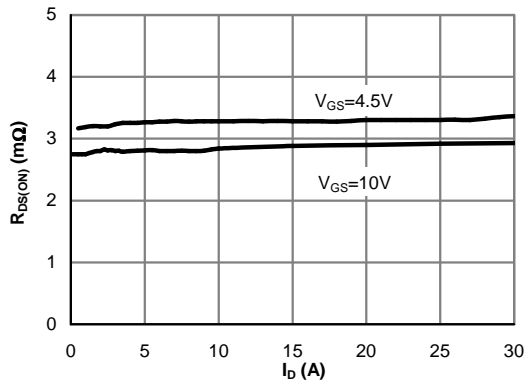

Figure 3: On-Resistance vs. Drain Current and Gate Voltage (Note E)

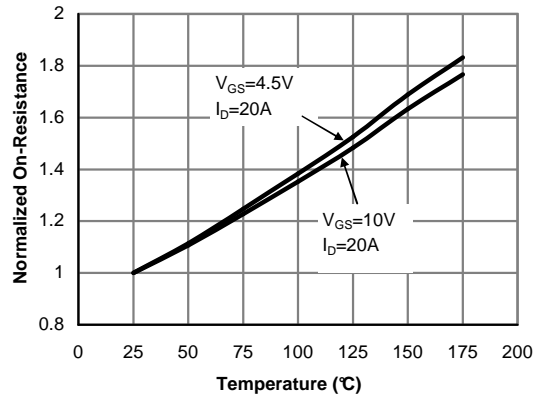

Figure 4: On-Resistance vs. Junction Temperature (Note E)

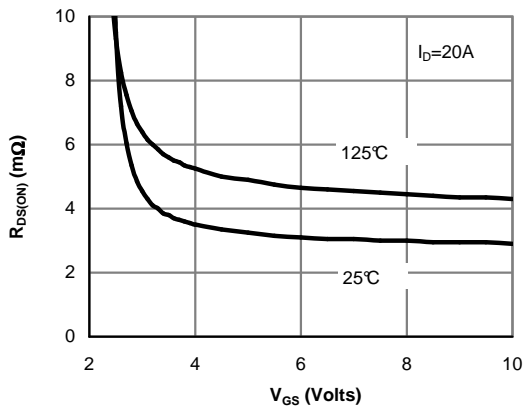

Figure 5: On-Resistance vs. Gate-Source Voltage (Note E)

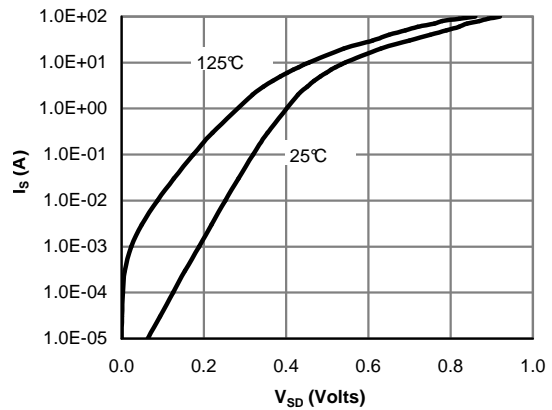

Figure 6: Body-Diode Characteristics (Note E)

Q2-CHANNEL: TYPICAL ELECTRICAL AND THERMAL CHARACTERISTICS

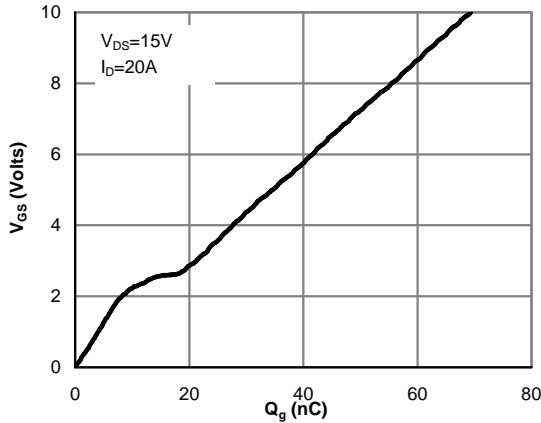

Figure 7: Gate-Charge Characteristics

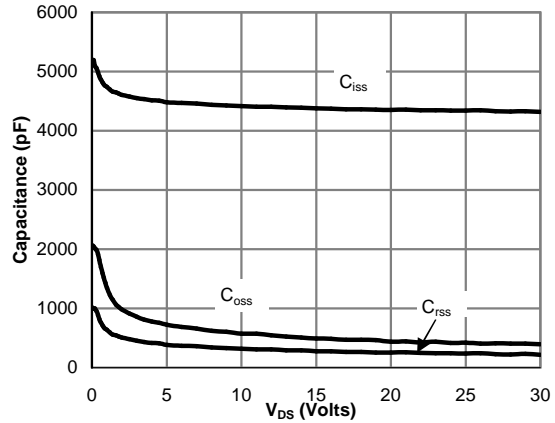

Figure 8: Capacitance Characteristics

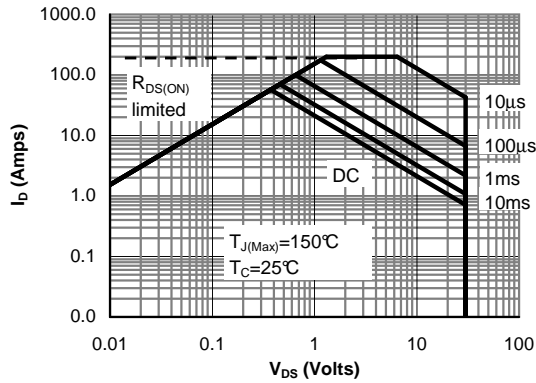

Figure 9: Maximum Forward Biased Safe Operating Area (Note F)

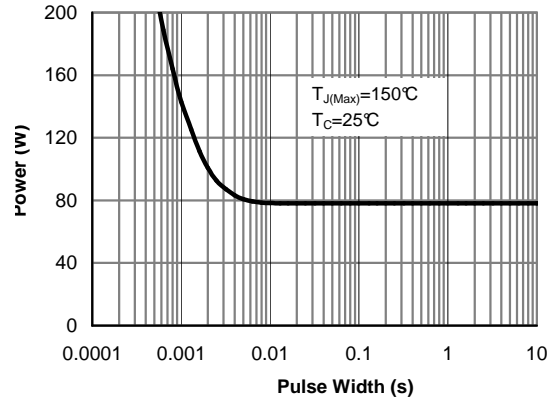

Figure 10: Single Pulse Power Rating Junction-to-Case (Note F)

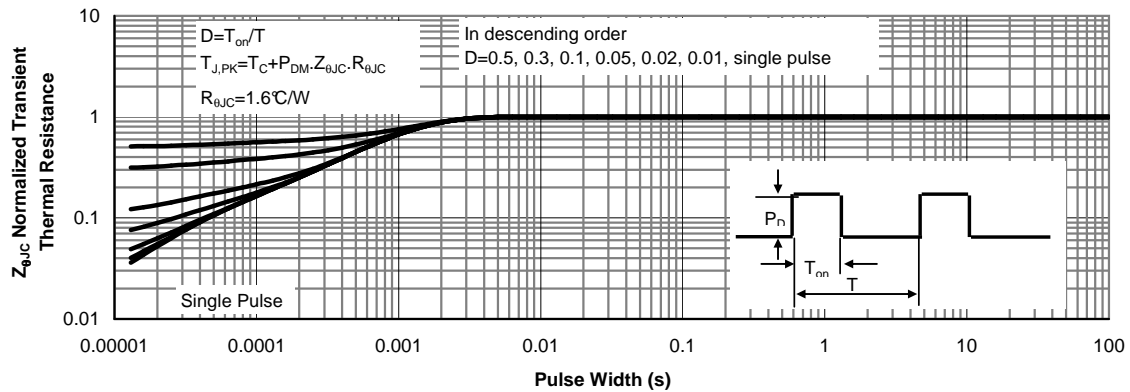

Figure 11: Normalized Maximum Transient Thermal Impedance (Note F)

Q2-CHANNEL: TYPICAL ELECTRICAL AND THERMAL CHARACTERISTICS

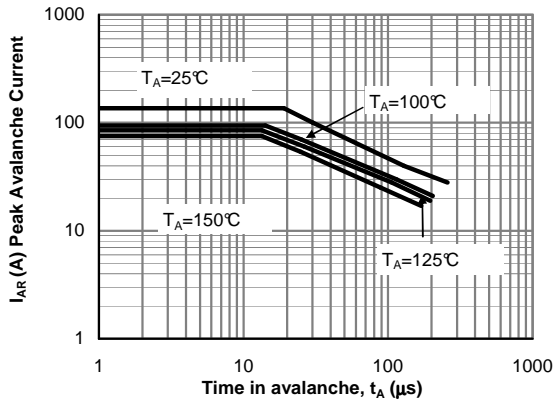

Figure 12: Single Pulse Avalanche capability (Note C)

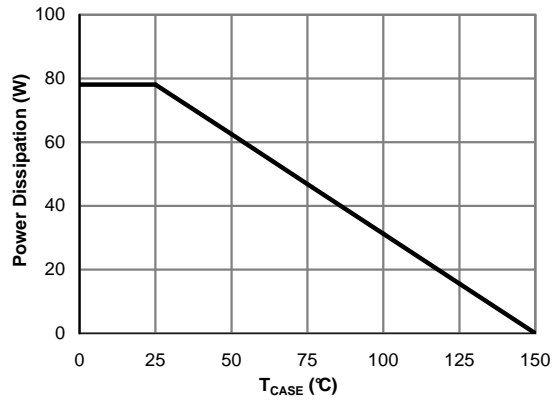

Figure 13: Power De-rating (Note F)

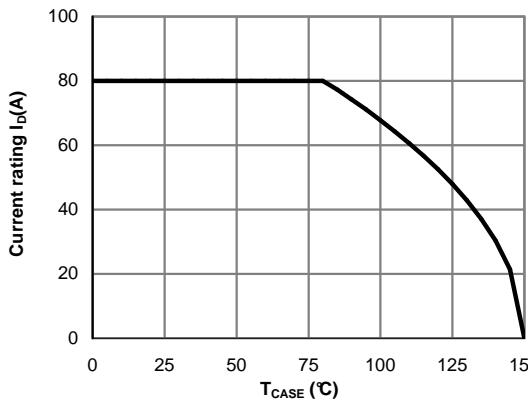

Figure 14: Current De-rating (Note F)

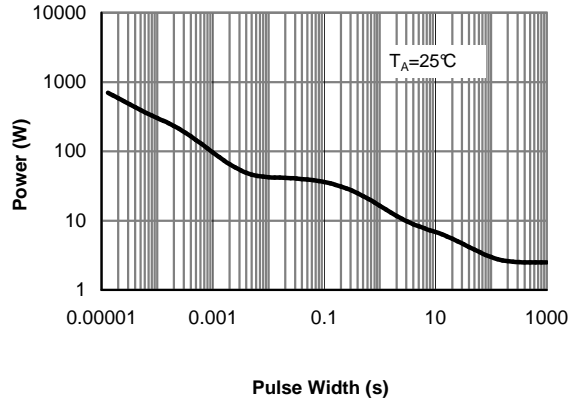

Figure 15: Single Pulse Power Rating Junction-to-Ambient (Note H)

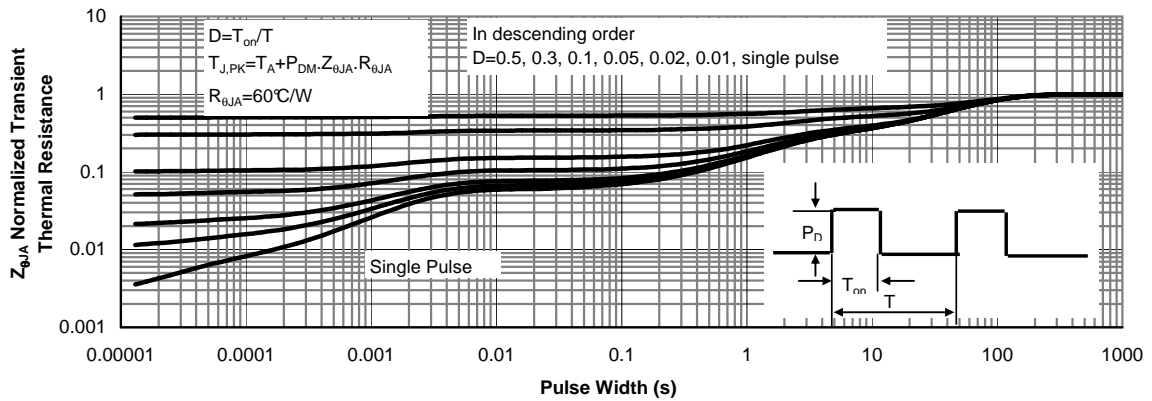

Figure 16: Normalized Maximum Transient Thermal Impedance (Note H)

Q2-CHANNEL: TYPICAL ELECTRICAL AND THERMAL CHARACTERISTICS

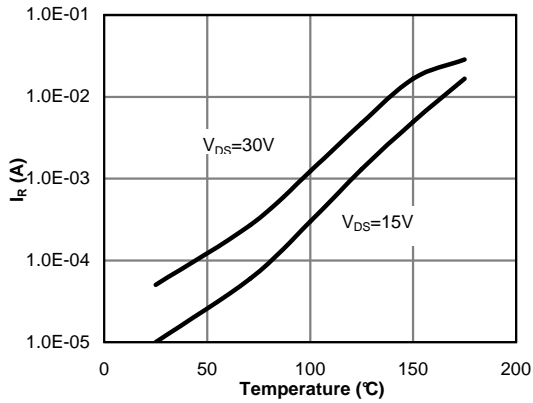

Figure 17: Diode Reverse Leakage Current vs. Junction Temperature

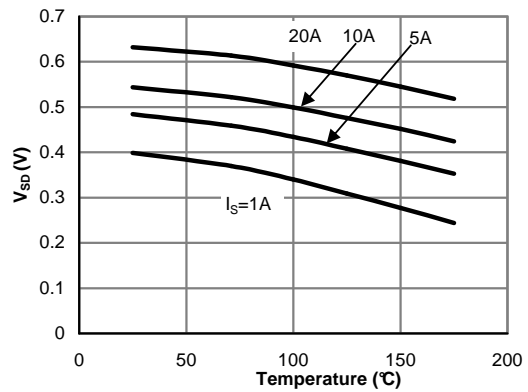

Figure 18: Diode Forward voltage vs. Junction Temperature

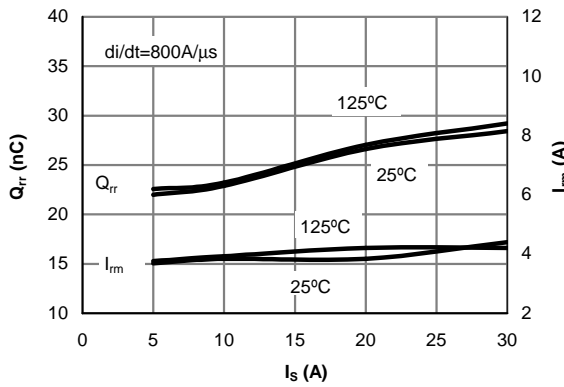

Figure 18: Diode Reverse Recovery Charge and Peak Current vs. Conduction Current

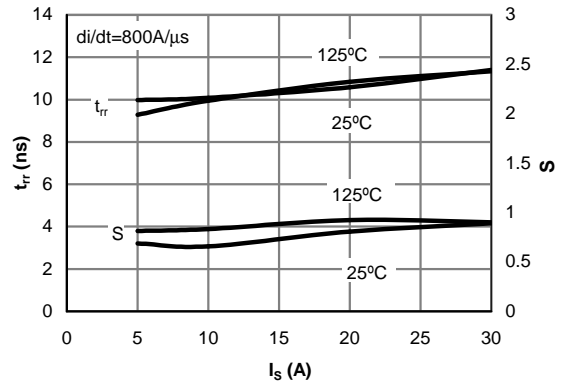

Figure 19: Diode Reverse Recovery Time and Softness Factor vs. Conduction Current

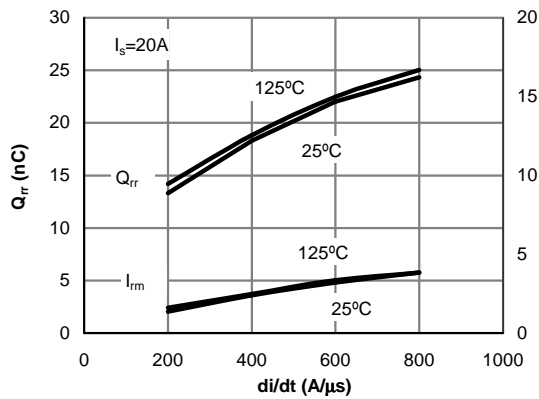

Figure 20: Diode Reverse Recovery Charge and Peak Current vs. di/dt

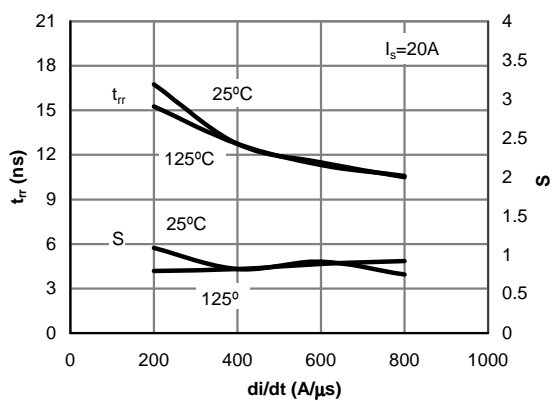
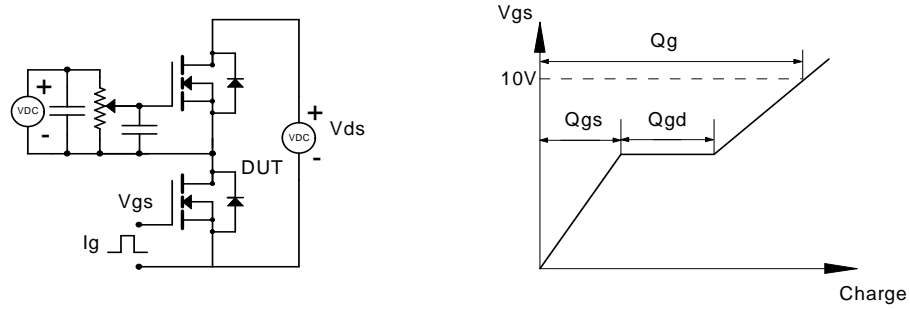
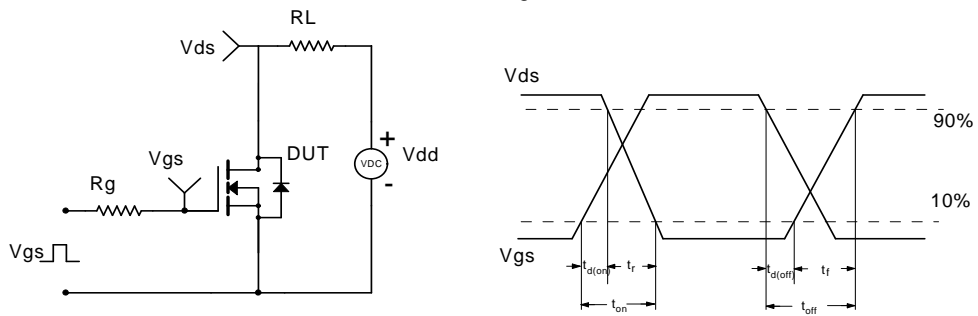

Figure 21: Diode Reverse Recovery Time and Softness Factor vs. di/dt

Gate Charge Test Circuit & Waveform



Resistive Switching Test Circuit & Waveforms



Unclamped Inductive Switching (UIS) Test Circuit & Waveforms

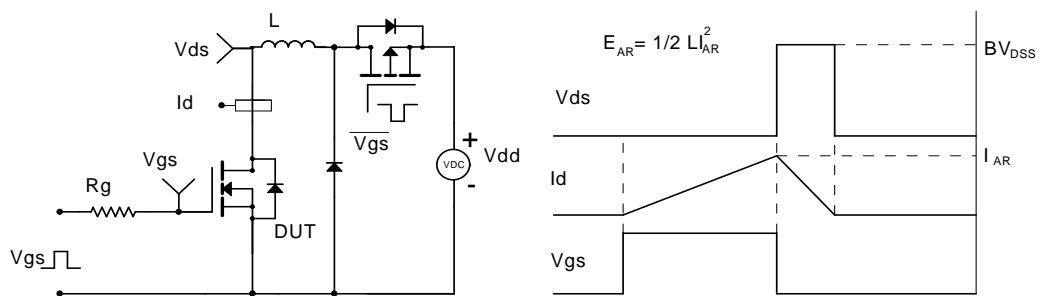

Diode Recovery Test Circuit & Waveforms

